

CPU Wall Cabinet

DIMENSIONS

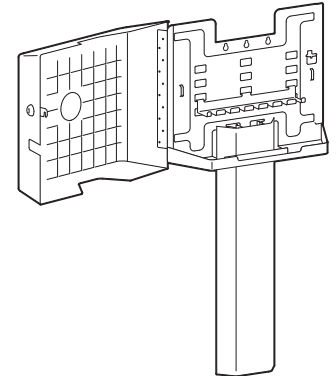
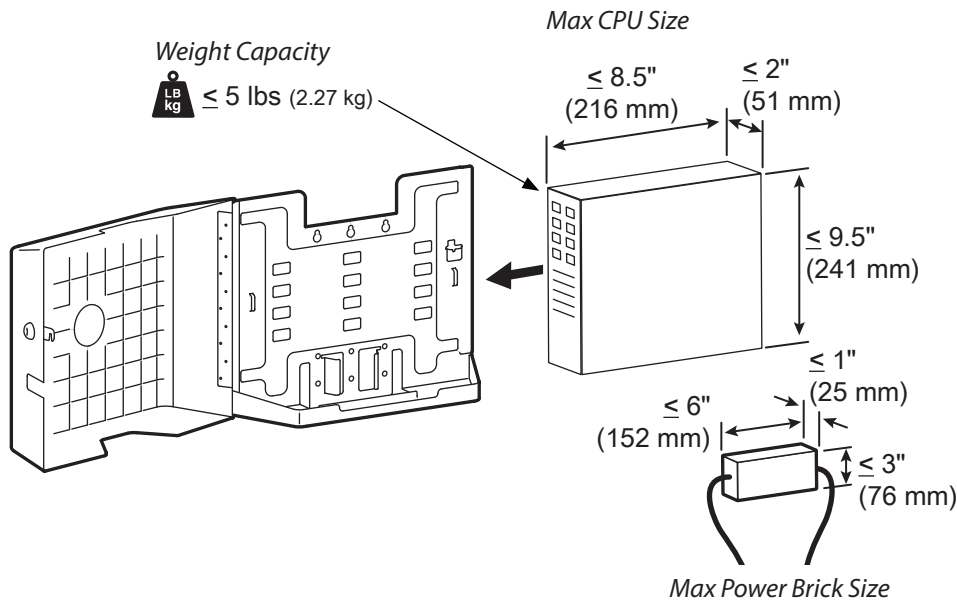

WALL MOUNTING OPTIONS

There are 4 wall types to mount to:

Wood (Provided mounting hardware)

Metal Stud (Provided mounting hardware)

Concrete (Need customer supplied fasteners)

Hollow Wall:

- Provided mounting hardware
- Wall must be 5/8" or 16mm thick.

When attaching to the CareFit™ Combo System, mounting method needs to be the same as the CareFit™ Combo System.

Cable Cover attaches to Ergotron Wall Track.



Download additional resources at ergotron.com

USA & Canada Sales & Corporate Headquarters: St. Paul, MN USA / 800.888.8458 / +1.651.681.7600 / insidesales@ergotron.com

EMEA Sales: Amersfoort, The Netherlands / +31.33.45.45.600 / info.eu@ergotron.com

APAC Sales: Sydney, Australia / apaccustomerservice@ergotron.com

LATAM Sales: Mexico / +1.800.681.1820 / info.latam@ergotron.com

Worldwide Custom Sales: custom@ergotron.com

Ergotron devices are not intended to cure, treat, mitigate or prevent any disease. Patent information available at www.ergotron.com/patents

© 2022 Ergotron, Inc. rev. 06/22/2022 DIM-CFArmCPUwall Content is subject to change without notification

CPU Wall Cabinet

DIMENSIONS

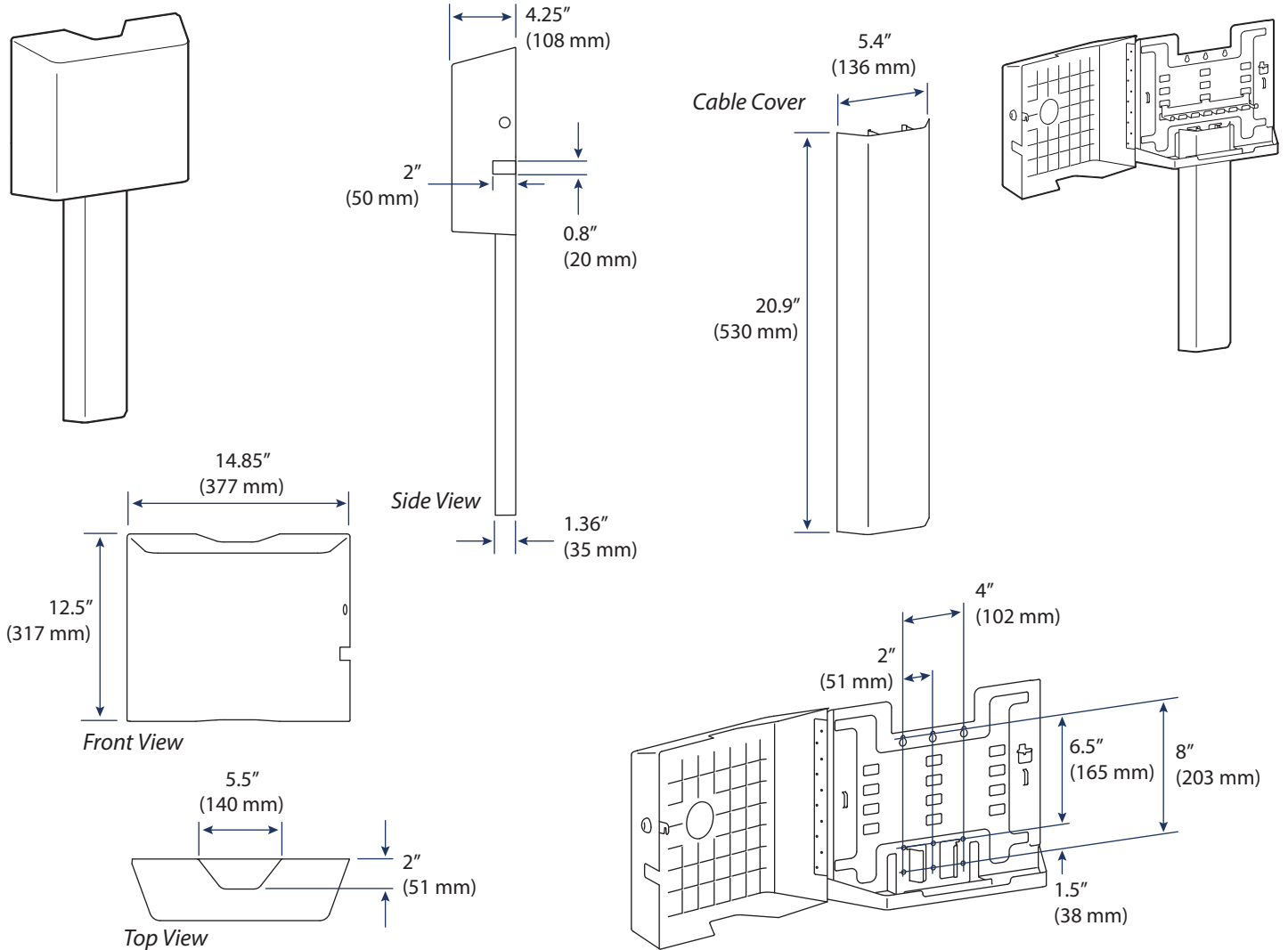

Used with Ergotron Wall Track

Mount Above Wall Track

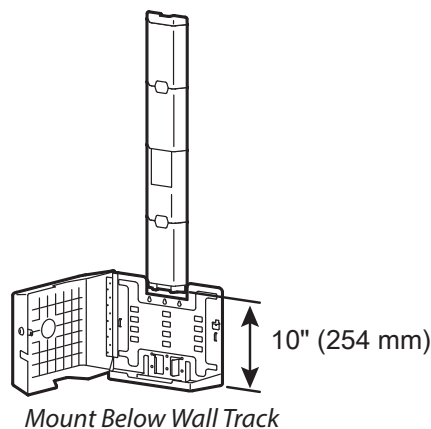
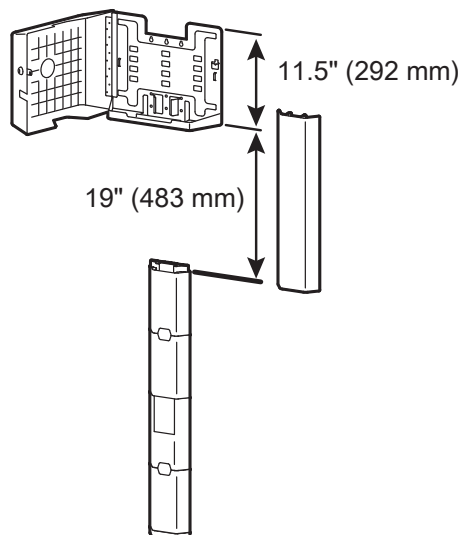

CPU Wall Cabinet

FEATURES

Cable storage

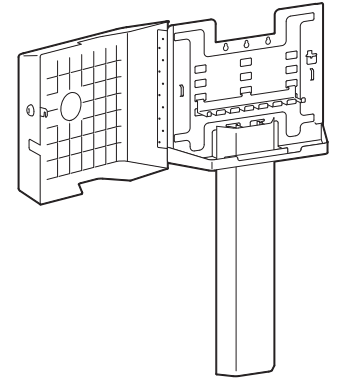
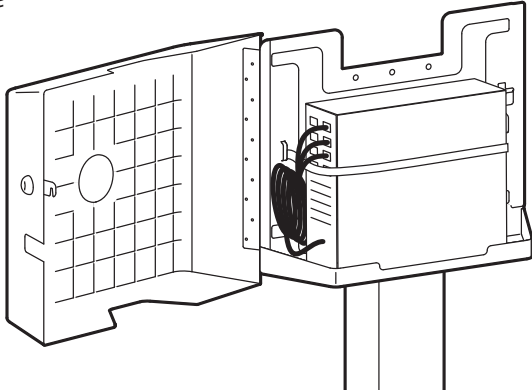

Cover with Lock

